

THE BLIND RELIEF ASSOCIATION NAGPUR'S  
**MUNDLE ENGLISH MEDIUM SCHOOL**  
**HOLIDAY HOMEWORK**

**STD. II**

**Note: Students must have finished the first set of holiday homework. Here we are sending the second set of holiday homework for the students.**

**ENGLISH**

**Q. 1. Repeat the following words 5 times :**

- |             |              |                  |              |
|-------------|--------------|------------------|--------------|
| 1) Bridge   | 6) Across    | 11) Centre       | 16) Comets   |
| 2) Rainbow  | 7) Chameleon | 12) Solar System | 17) Archery  |
| 3) Sail     | 8) Seldom    | 13) Planets      | 18) Warcraft |
| 4) Unity    | 9) Overtop   | 14) Telescope    | 19) Shoot    |
| 5) Strength | 10) Dream    | 15) Glasses      | 20) Kitchen  |

**Q. 2. Write 5 names of your friend. Arrange the names in alphabetical order.**

**Q. 3. Write Person, Place, Animal, Things starting with the following letters.**

Letter	Person	Place	Animal	Thing
S				
P				
O				
T				
D				
V				
U				
L				

**List of Opposites (Antonyms) :**

- |                     |                          |
|---------------------|--------------------------|
| 1) First × Last     | 11) Late × Early         |
| 2) Dry × Wet        | 12) Slow × Fast          |
| 3) Pull × Push      | 13) Night × Day          |
| 4) Rough × Smooth   | 14) Top × Bottom         |
| 5) Brave × Coward   | 15) Fresh × Stale        |
| 6) Follow × Lead    | 16) Active × Lazy        |
| 7) Correct × Wrong  | 17) Full × Empty         |
| 8) Below × Above    | 18) Heavy × Light        |
| 9) Same × Different | 19) Short × Long         |
| 10) None × All      | 20) Begin × End / Finish |

**NOTE : Repeat the list of opposites and learn well. Then solve the following Antonym Crossword Puzzle.**

**Q. 4. Antonym Crossword Puzzle :**

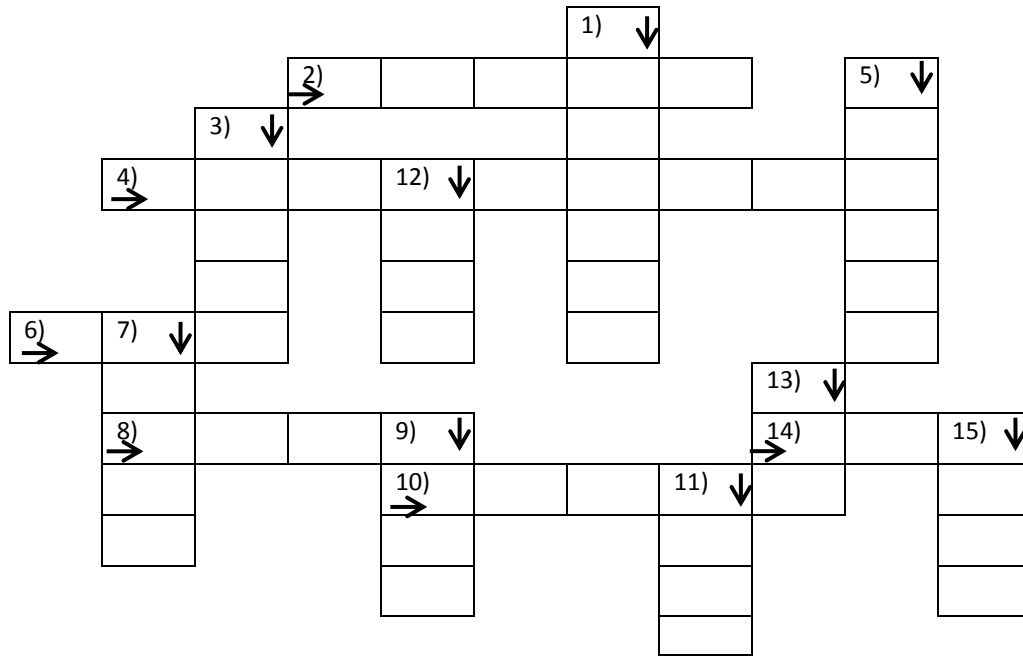

**Across :**

- 2) Above
- 4) Same
- 6) Dry
- 8) Push
- 10) Late
- 12) Slow
- 14) None

**Down :**

- 1) Wrong
- 3) Heavy
- 5) Top
- 7) Full
- 9) Follow
- 11) First
- 13) Night
- 15) Short

**Q. 5. Use the direction key to colour hot chocolate mug.**

Adjective – Colour it Red  
Pronoun – Colour it Green

Preposition – Blue  
Adverb – Yellow

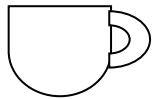

Shiny

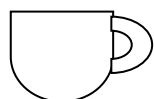

He

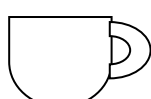

on

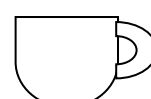

clever

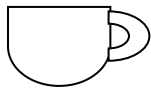

She

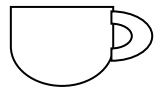

beautifully

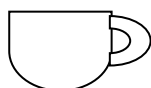

above

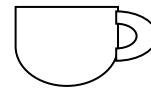

carefully

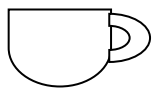

under

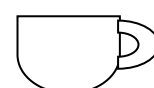

They



brown



slowly

**Q. 6. Find the following words from the given maze. Time limit – 15 minutes.**

U	M	O	N	K	E	Y	W	N	O	C
H	F	I	S	H	P	R	X	S	P	H
O	D	L	C	D	G	I	F	T	Q	A
R	K	I	T	E	Q	N	Y	A	Z	I
S	I	X	Z	G	Z	D	D	R	X	R
E	N	O	B	N	E	I	A	L	N	L
F	G	E	E	X	B	A	F	O	X	M
A	P	P	L	E	R	S	N	C	N	Q
D	N	L	R	Z	A	T	M	K	D	F
E	F	Q	S	T	E	A	C	H	E	R

- 1) Mice
- 2) Kite
- 3) King
- 4) Apple
- 5) Gift
- 6) India
- 7) Lock
- 8) Teacher
- 9) Fox
- 10) Star
- 11) Monkey
- 12) Chair
- 13) Pen
- 14) Horse
- 15) Fish
- 16) Zebra

**Q. 7. Join the word pieces to make the compound word. One has been done for you.**

- 1) Black + board = Blackboard
- 2) Ice + cream = \_\_\_\_\_
- 3) Foot + ball = \_\_\_\_\_
- 4) Ant + hill = \_\_\_\_\_
- 5) Watch + man = \_\_\_\_\_
- 6) Cup + board = \_\_\_\_\_
- 7) Sun + flower = \_\_\_\_\_

**Find more compound words and write them in your copy.**

**Q. 8. To improve handwriting write one page everyday from English textbook.**

**मराठी**

- 1) कुटुंबातील व्यक्तित्ते फोटो लावून 'कुटुंब वृक्ष' (Family Tree) तयार करा.
- 2) स्वतःचा पूर्ण परिचय (मराठीत) लिहा.
- 3) अंक १ ते ३० अंकात व अक्षरात लिहा.

## हिन्दी

- 1) वर्णमाला ५ बार लिखो
- 2) जंगली एवं पालतू जानवरो के नाम लिखो
- 3) मिट्टी के ५ फल एवं ५ सब्जियाँ बनाओ (रंग भरो)

## MATHEMATICS

- 1) Solve five addition sums with carrying over and without carrying over once in a week.
- 2) Solve five subtraction sums with borrowing and without borrowing once in a week.
- 3) Solve five multiplication sums once in a week.
- 4) Draw shapes square, rectangle, circle and triangle. Learn their properties once in a week.
- 5) Write two multiplication tables daily (2 to 20).

.....